

CORTINAS PLISADAS TÉRMICAS
PERFECT FIT
GUÍA DE INSTALACIÓN

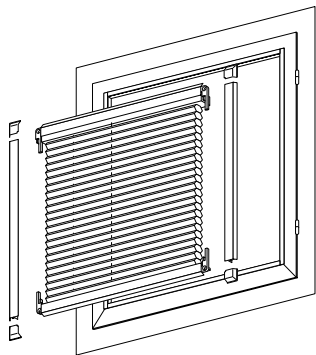

1.

CORTINAS PLISADAS TÉRMICAS PERFECT FIT

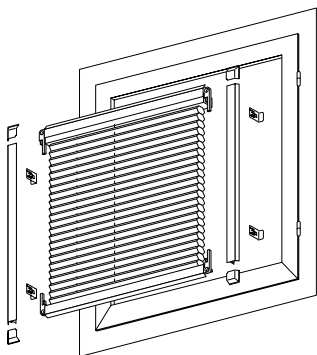
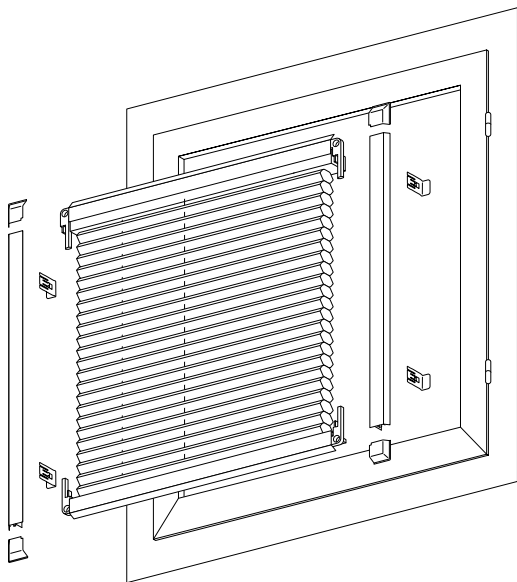

Comprobar piezas

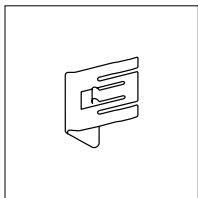

Soportes

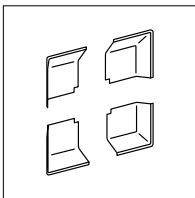

Embellecedores

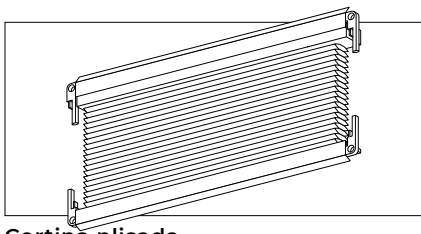

Cortina plisada

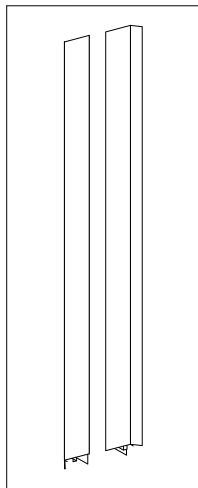

Guías laterales

Necesitamos

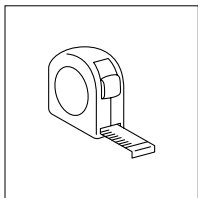

Cinta métrica

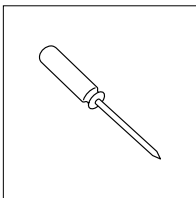

Destornillador

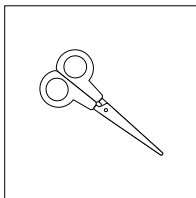

Tijeras

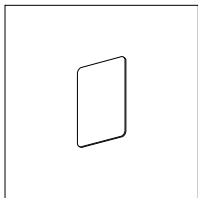

**Tarjeta
de crédito**

1| Unimos las guías laterales

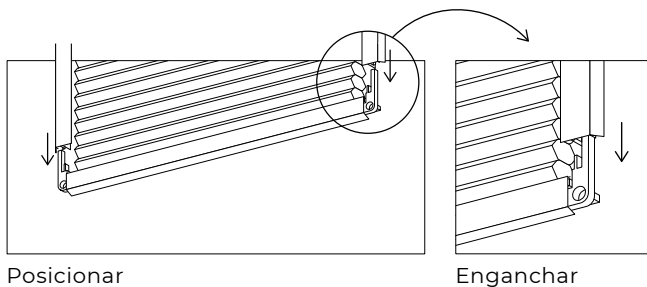
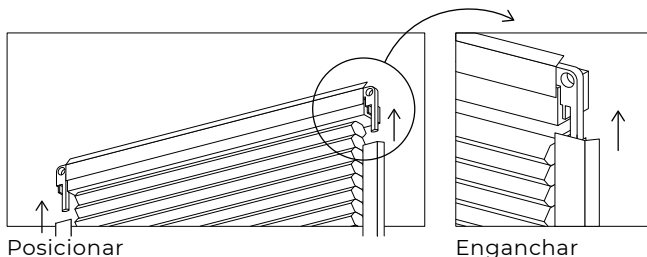

Posicionamos las guías a cada lado de la cortina
y **las enganhamos** al perfil superior y al perfil inferior.

2 | Colocamos los embellecedores

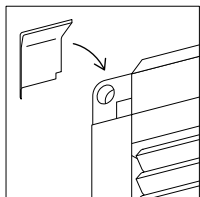

Colocar

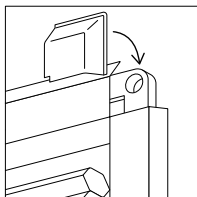

Colocar

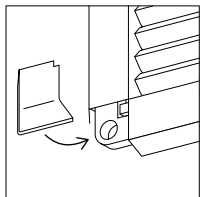

Colocar

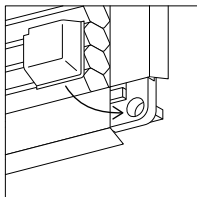

Colocar

3 | Fijamos las esquinas

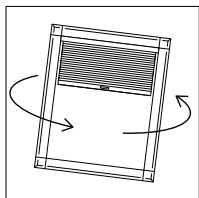

Girar

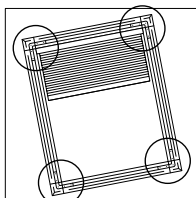

Visualizar

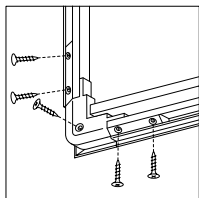

Fijar

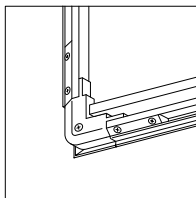

Giramos el marco y, en la parte trasera, **visualizamos** los agujeros que están en cada esquina. **Fijamos** los tornillos en los agujeros y **repetimos** la operación en cada esquina del marco.

4 | Enganchamos los soportes

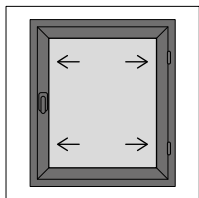

Ubicar

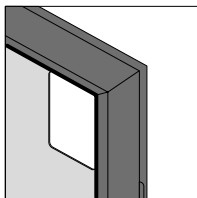

Posicionar

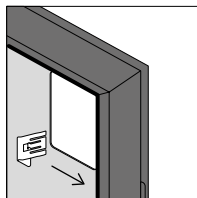

Colocar

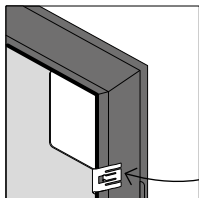

Ajustar

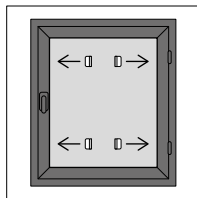
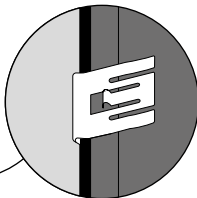

Colocar

Los soportes se colocan dentro de la junta de silicona del marco de la ventana. **Los colocamos** en los laterales con ayuda de la tarjeta para **ubicarlos** a una distancia correcta de la esquina.

5 | Colocamos la cortina plisada

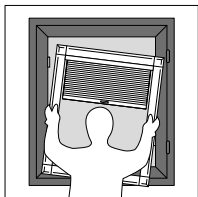

Posicionar

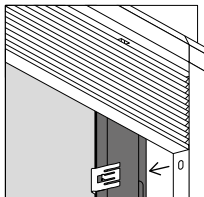

Colocar

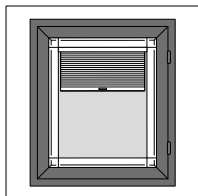
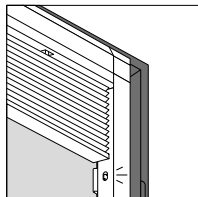

Posicionamos la cortina plisada en frente de los soportes y **la enganchamos** hasta que haga « clic » en todos los soportes.

2.

CORTINAS PLISADAS TÉRMICAS PERFECT FIT CON IMÁN

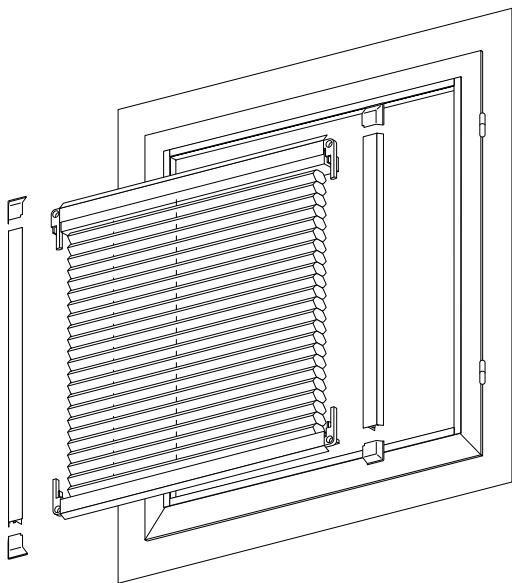

Comprobar piezas

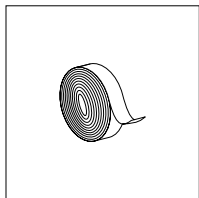

Cinta magnética

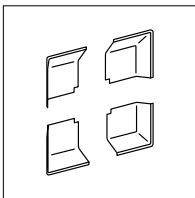

Embellecedores

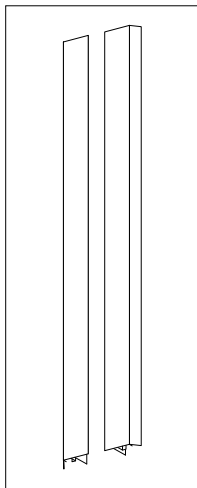

Guías laterales

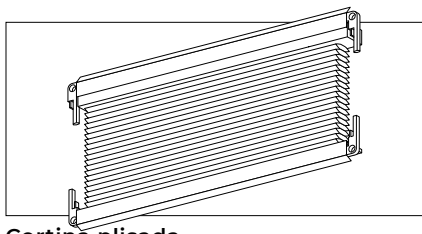

Cortina plisada

Necesitamos

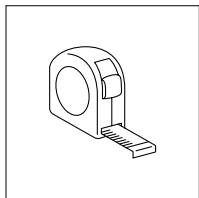

Cinta métrica

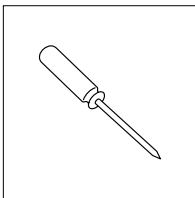

Destornillador

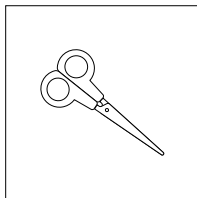

Tijeras

1| Unimos las guías laterales

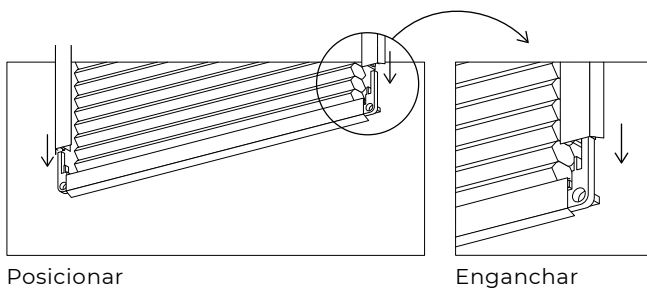
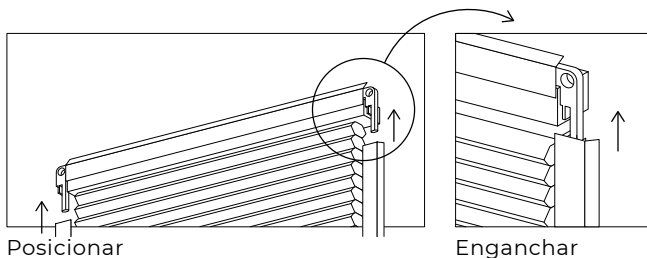

Posicionamos las guías a cada lado de la cortina
y **las enganhamos** al perfil superior y al perfil inferior.

2 | Colocamos los embellecedores

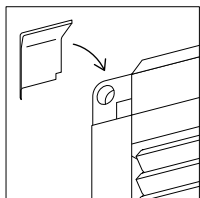

Colocar

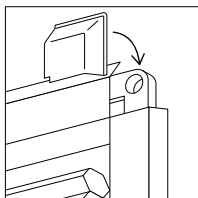

Colocar

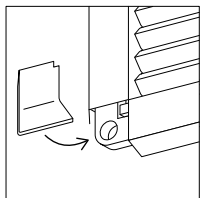

Colocar

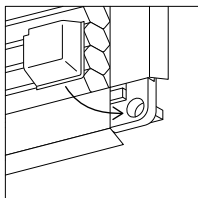

Colocar

3 | Fijamos las esquinas

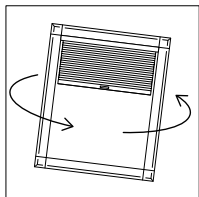

Girar

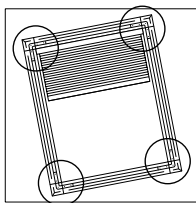

Visualizar

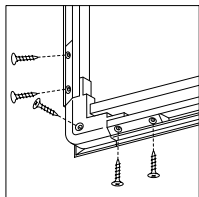

Fijar

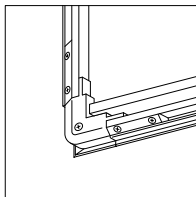

Giramos el marco y en la parte trasera **visualizamos** los agujeros que están en cada esquina. **Fijamos** los tornillos en los agujeros y **repetimos** la operación en cada esquina del marco.

4 | Preparamos la cinta magnética

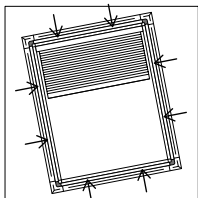

Visualizar

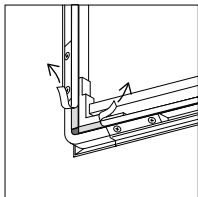
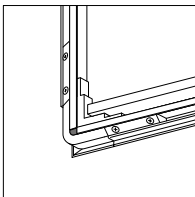

Quitar

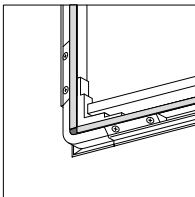

Visualizamos el sitio donde hay la cinta magnética y **quitamos** el papel protector de la cinta.

5 | Pegamos la cortina plisada

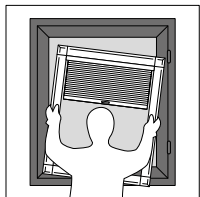

Posicionar

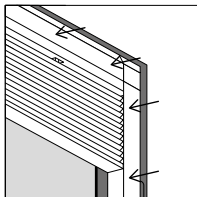

Presionar

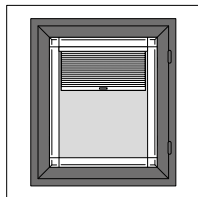

Quitar

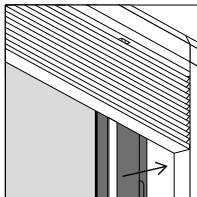
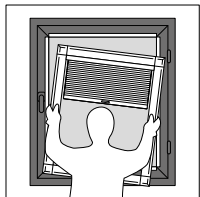

Quitar

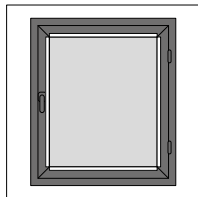

Verificar

Posicionamos la cortina plisada en frente de la cinta magnética y **la colocamos. Aplicamos** un presión sobre el marco de la plisada para que la cinta magnética se pegue al marco de la ventana. **Retiramos** la plisada y **verificamos** que la cinta está firmemente adherida.

Atención al cliente

soporte@cortinadecor.com

966 181 033

www.cortinadecor.com